

KAMINEINSÄTZE GAS



BKG 4.0 Flach 54-68

Stand: 2023-11-21



BRUNNER[®]
by **barbas**.

Maßblätter - BKG 4.0 Flach 54-68

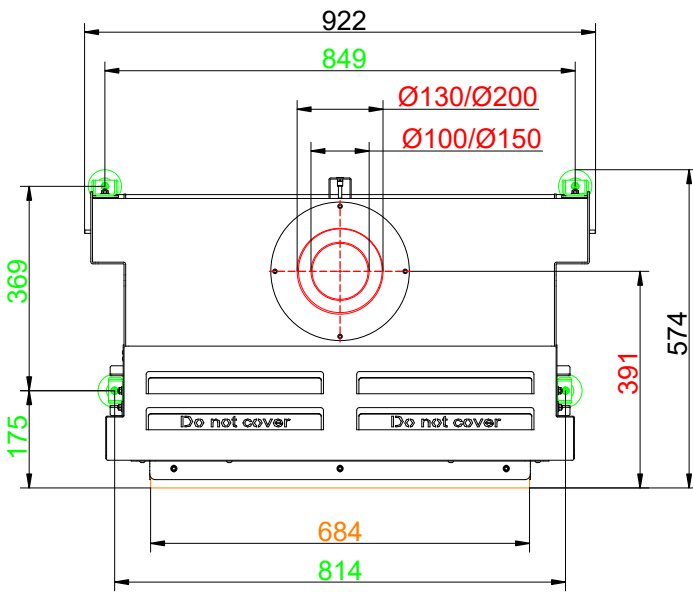
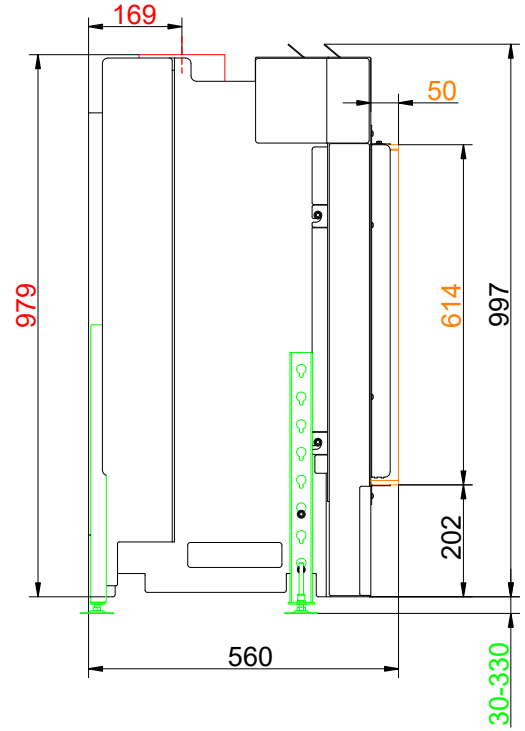
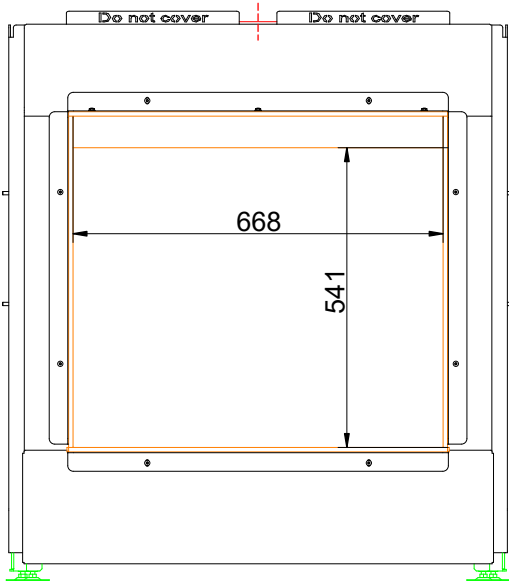

... mit Anbaurahmen 50 mm und Stellfüße lang

Maßblätter - BKG 4.0 Flach 54-68

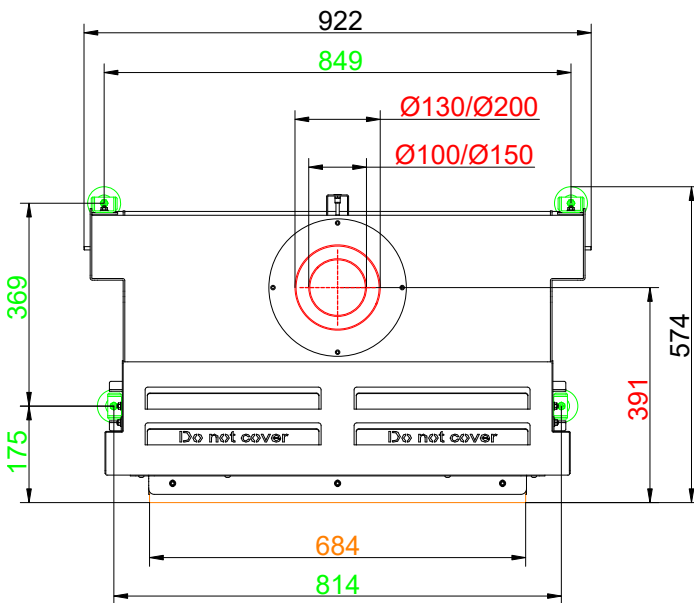
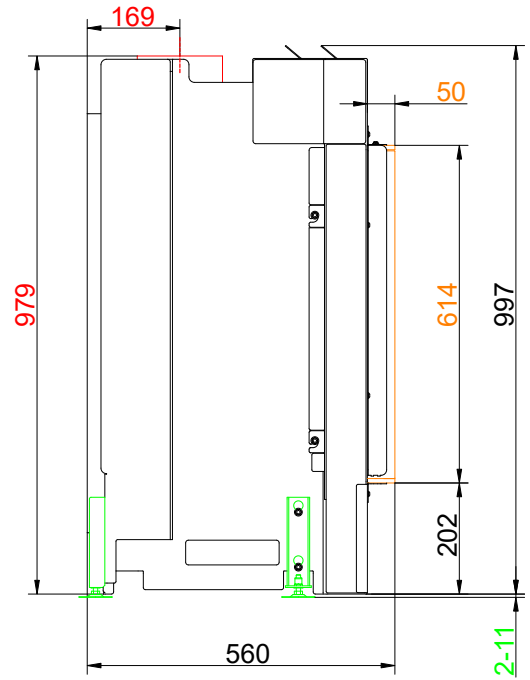
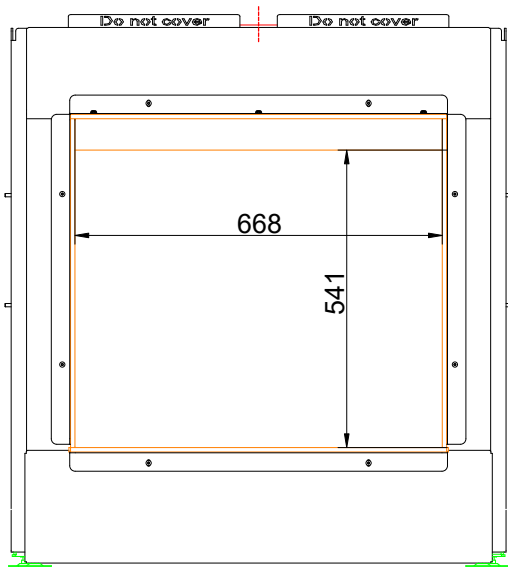

... mit Anbaurahmen 50 mm

Für Zeichnungsdaten zur CAD-Planung empfehlen wir PaletteCAD. Laufend aktualisierte Maßzeichnungen unter www.brunner.de
 Rahmen / LAS-Stützen / Stellfüße und Zubehör farblich markiert.

BRUNNER LAS (Gas) - BKG 4.0 Flach 54-68

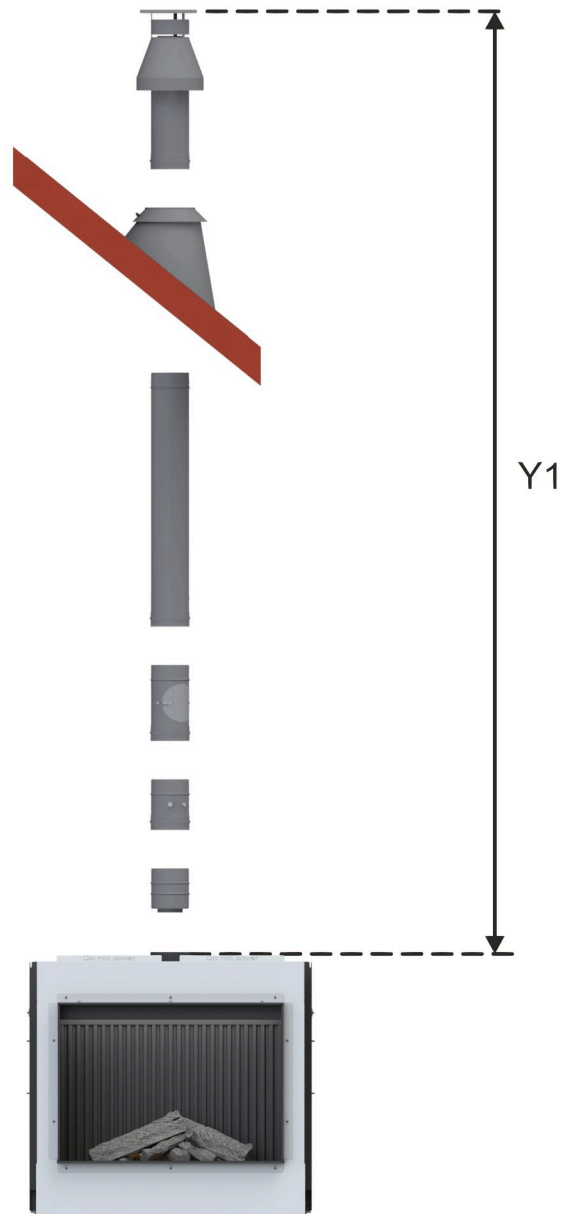

Abstand Y1 (min. - max.)	Abstand X1 (min. - max.)	Abstand Y2 (min. - max.)	Abstand X2 (min. - max.)	Stauplatte (Breite)
2,0 - 4,0 m				30 mm
4,0 - 12,0 m				40 mm

BRUNNER LAS (Gas) - BKG 4.0 Flach 54-68

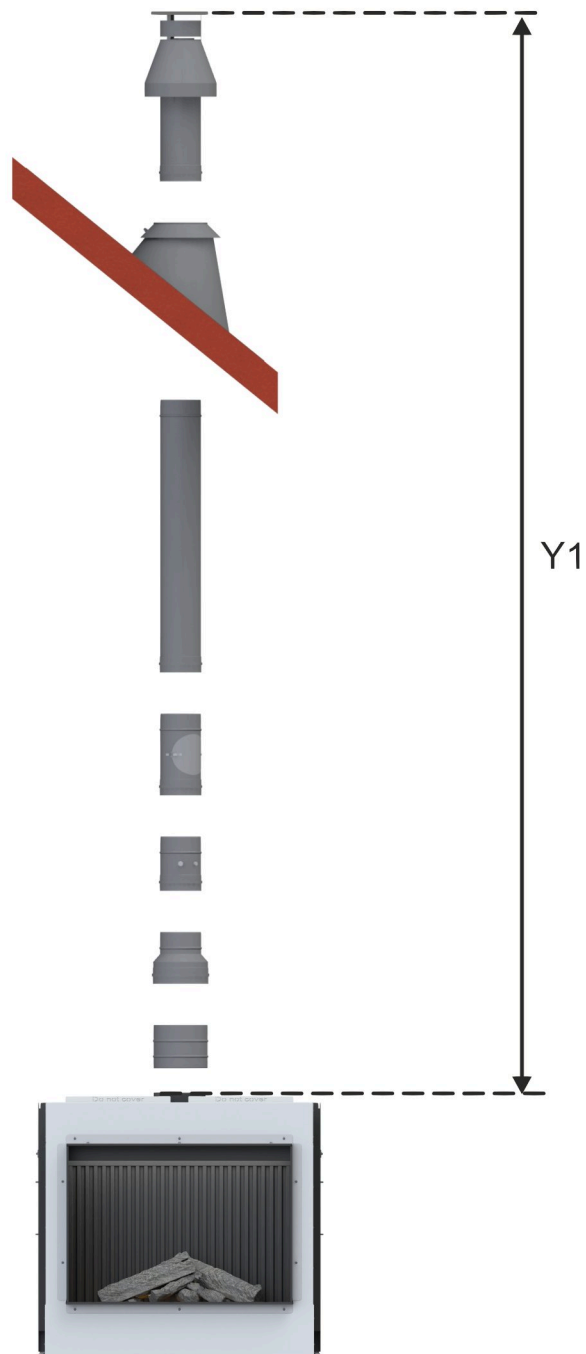

Abstand Y1 (min. - max.)	Abstand X1 (min. - max.)	Abstand Y2 (min. - max.)	Abstand X2 (min. - max.)	Stauplatte (Breite)
2,0 - 4,0 m				65 mm
4,0 - 12,0 m				80 mm

BRUNNER LAS (Gas) - BKG 4.0 Flach 54-68

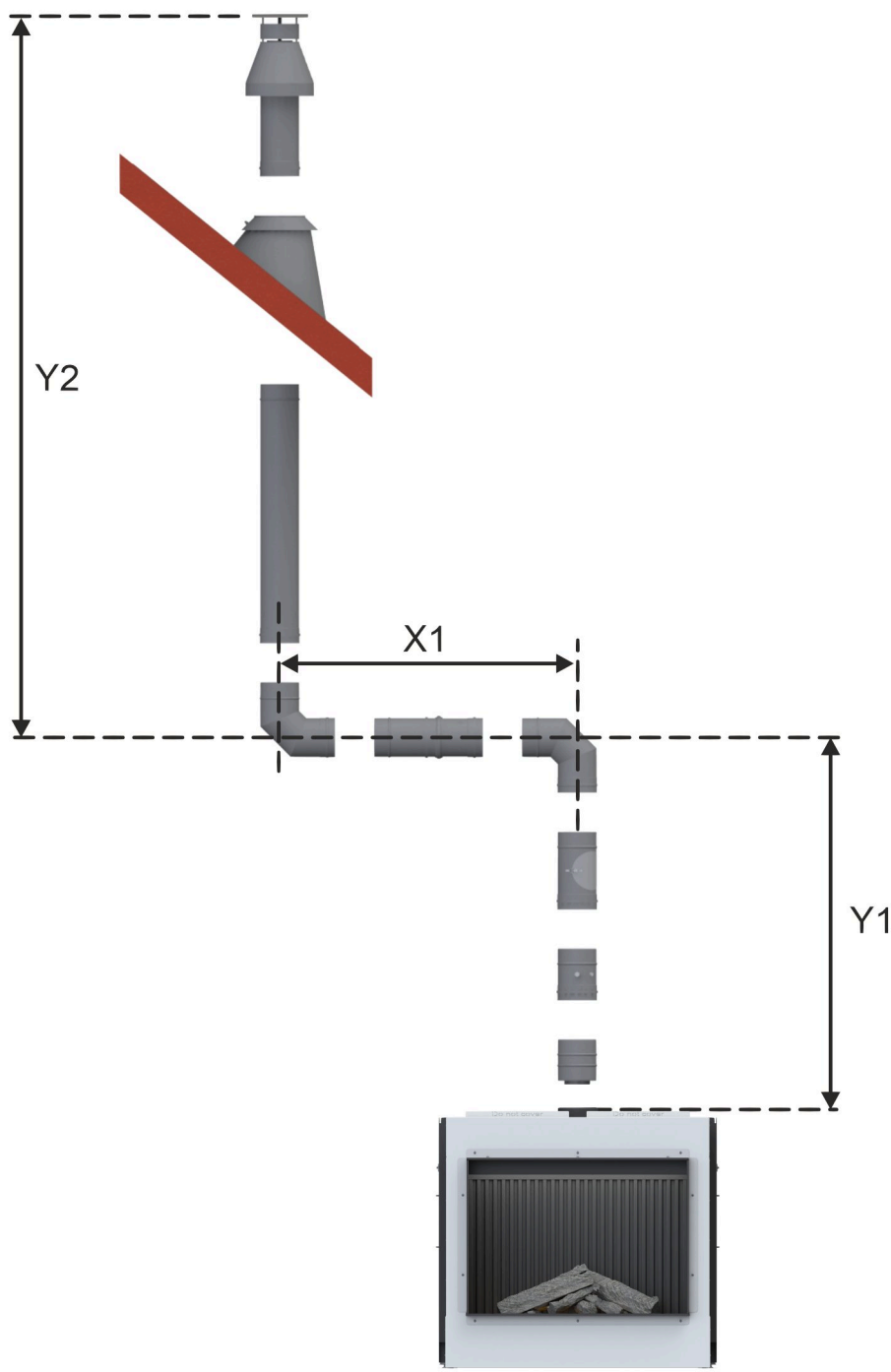

Abstand Y1 (min. - max.)	Abstand X1 (min. - max.)	Abstand Y2 (min. - max.)	Abstand X2 (min. - max.)	Stauplatte (Breite)
1,15 - 9,85 m	0,3 - 3,3 m	1,15 - 9,85 m		-

$Y1 + Y2 \leq 11,0 \text{ m}$
 $(Y1 + Y2) : X1 \geq 2:1$, Verhältnis vertikal zu horizontal min. 2:1

BRUNNER LAS (Gas) - BKG 4.0 Flach 54-68

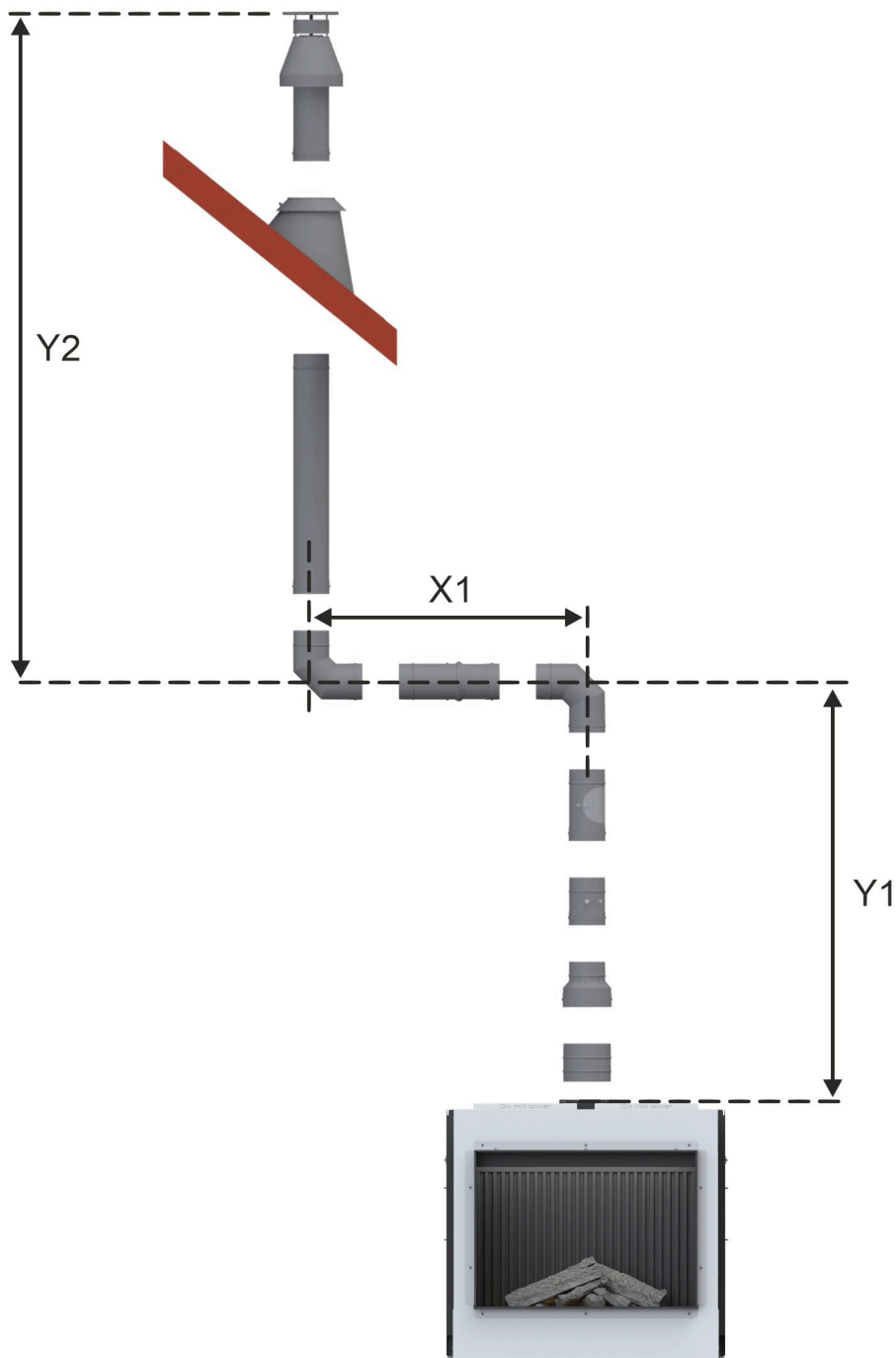

Abstand Y1 (min. - max.)	Abstand X1 (min. - max.)	Abstand Y2 (min. - max.)	Abstand X2 (min. - max.)	Stauplatte (Breite)
1,15 - 9,85 m	0,3 - 3,3 m	1,15 - 9,85 m		40 mm

$Y1 + Y2 \leq 11,0 \text{ m}$
 $(Y1 + Y2) : X1 \geq 2:1$, Verhältnis vertikal zu horizontal min. 2:1

BRUNNER LAS (Gas) - BKG 4.0 Flach 54-68

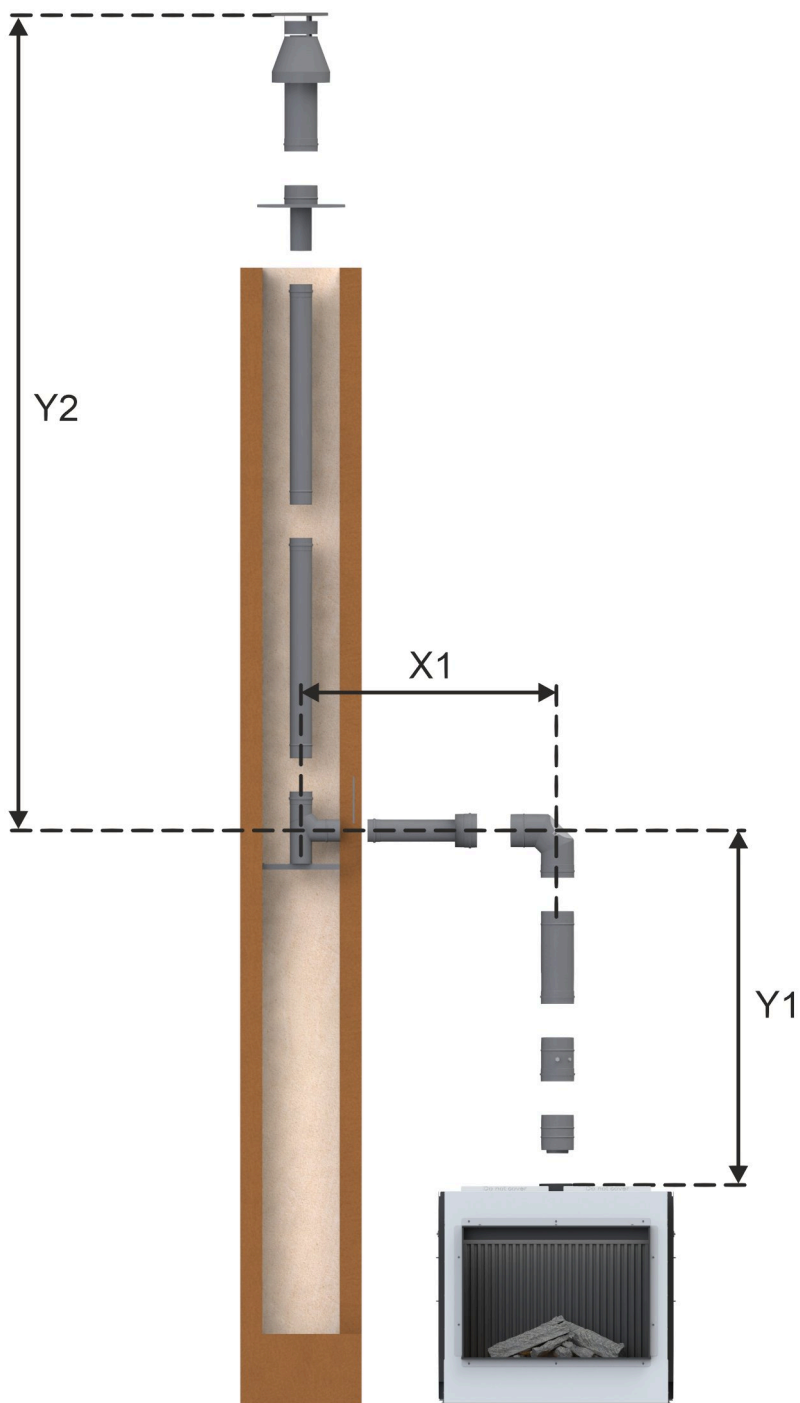

Abstand Y1 (min. - max.)	Abstand X1 (min. - max.)	Abstand Y2 (min. - max.)	Abstand X2 (min. - max.)	Stauplatte (Breite)
1,15 - 9,9 m	0,15 - 3,15 m	1,1 - 9,85 m		-

$Y1 + Y2 \leq 11,0 \text{ m}$
 $(Y1 + Y2) : X1 \geq 2:1$, Verhältnis vertikal zu horizontal min. 2:1

BRUNNER LAS (Gas) - BKG 4.0 Flach 54-68

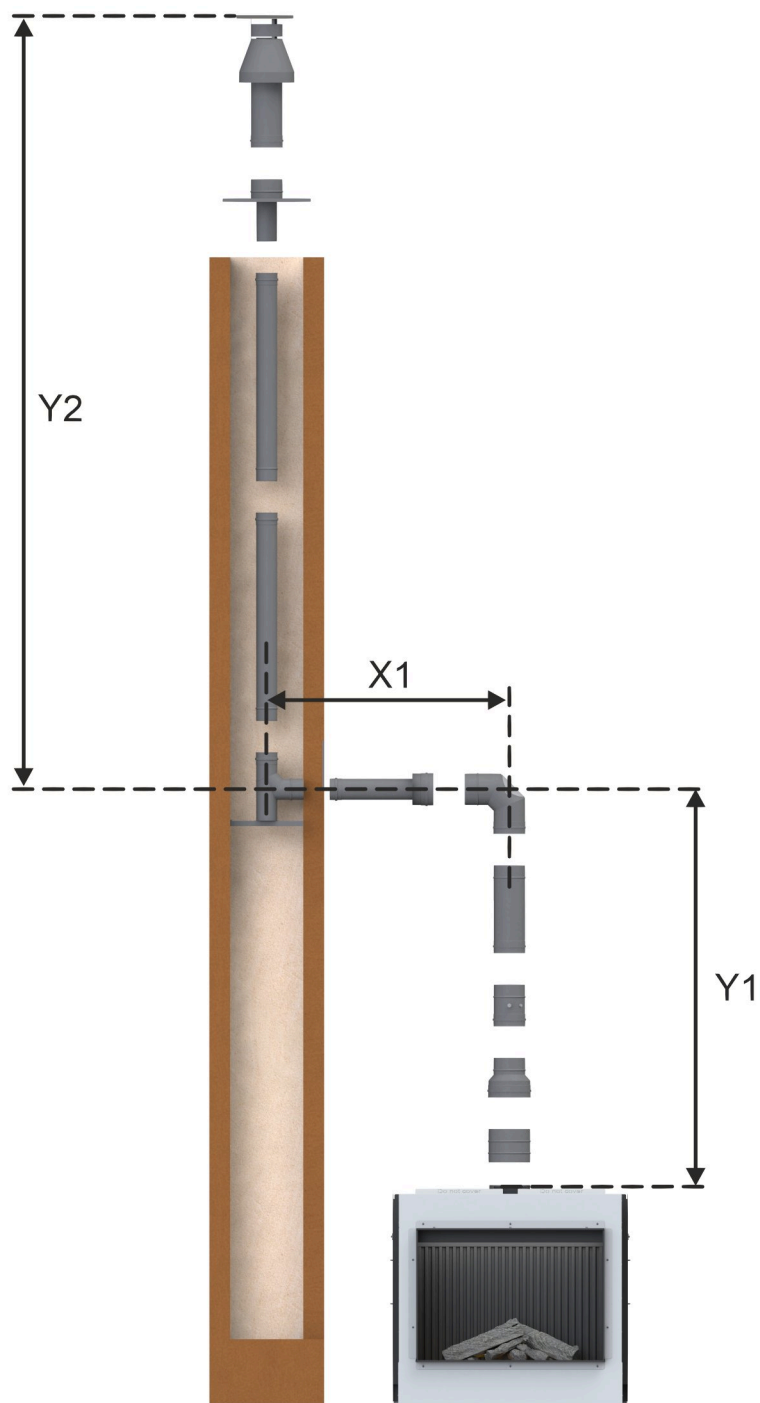

Abstand Y1 (min. - max.)	Abstand X1 (min. - max.)	Abstand Y2 (min. - max.)	Abstand X2 (min. - max.)	Stauplatte (Breite)
1,15 - 9,9 m	0,15 - 3,15 m	1,1 - 9,85 m		40 mm

$Y1 + Y2 \leq 11,0 \text{ m}$
 $(Y1 + Y2) : X1 \geq 2:1$, Verhältnis vertikal zu horizontal min. 2:1

BRUNNER LAS (Gas) - BKG 4.0 Flach 54-68

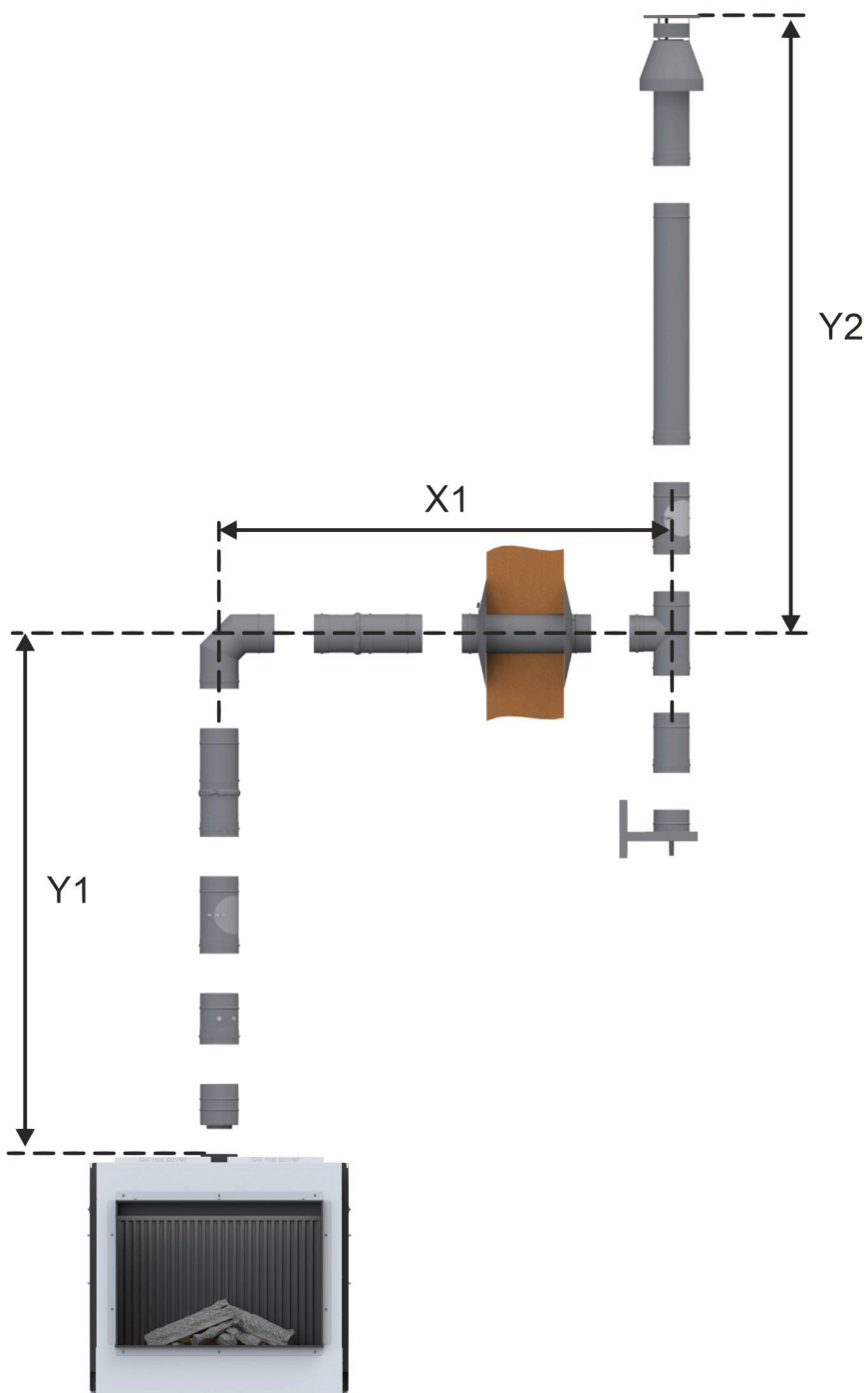

Abstand Y1 (min. - max.)	Abstand X1 (min. - max.)	Abstand Y2 (min. - max.)	Abstand X2 (min. - max.)	Stauplatte (Breite)
1,15 - 9,9 m	0,15 - 3,15 m	1,1 - 9,85 m		-

$Y1 + Y2 \leq 11,0 \text{ m}$
 $(Y1 + Y2) : X1 \geq 2:1$, Verhältnis vertikal zu horizontal min. 2:1

BRUNNER LAS (Gas) - BKG 4.0 Flach 54-68

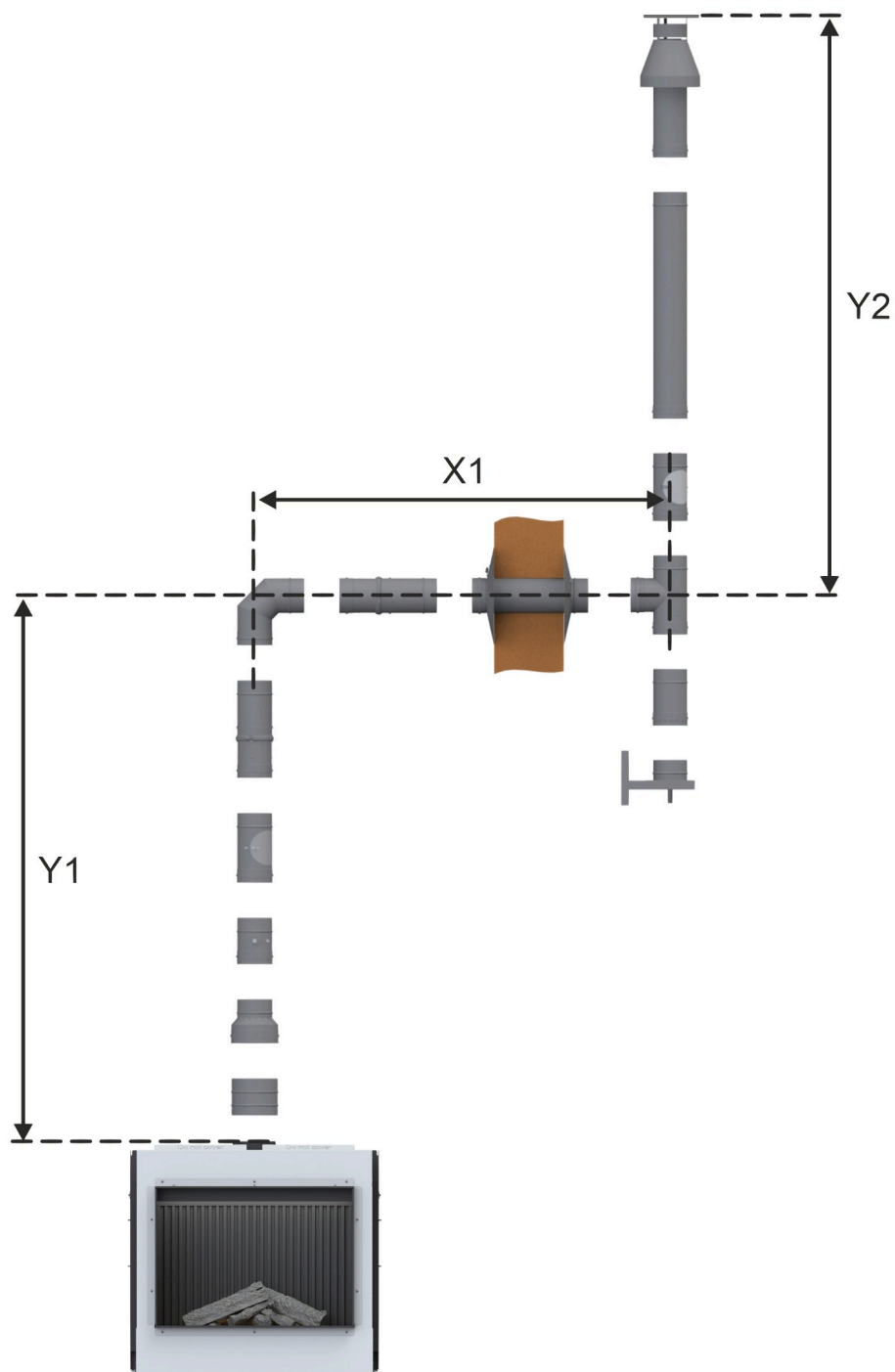

Abstand Y1 (min. - max.)	Abstand X1 (min. - max.)	Abstand Y2 (min. - max.)	Abstand X2 (min. - max.)	Stauplatte (Breite)
1,15 - 9,9 m	0,15 - 3,15 m	1,1 - 9,85 m		40 mm

$Y1 + Y2 \leq 11,0 \text{ m}$
 $(Y1 + Y2) : X1 \geq 2:1$, Verhältnis vertikal zu horizontal min. 2:1

BRUNNER LAS (Gas) - BKG 4.0 Flach 54-68

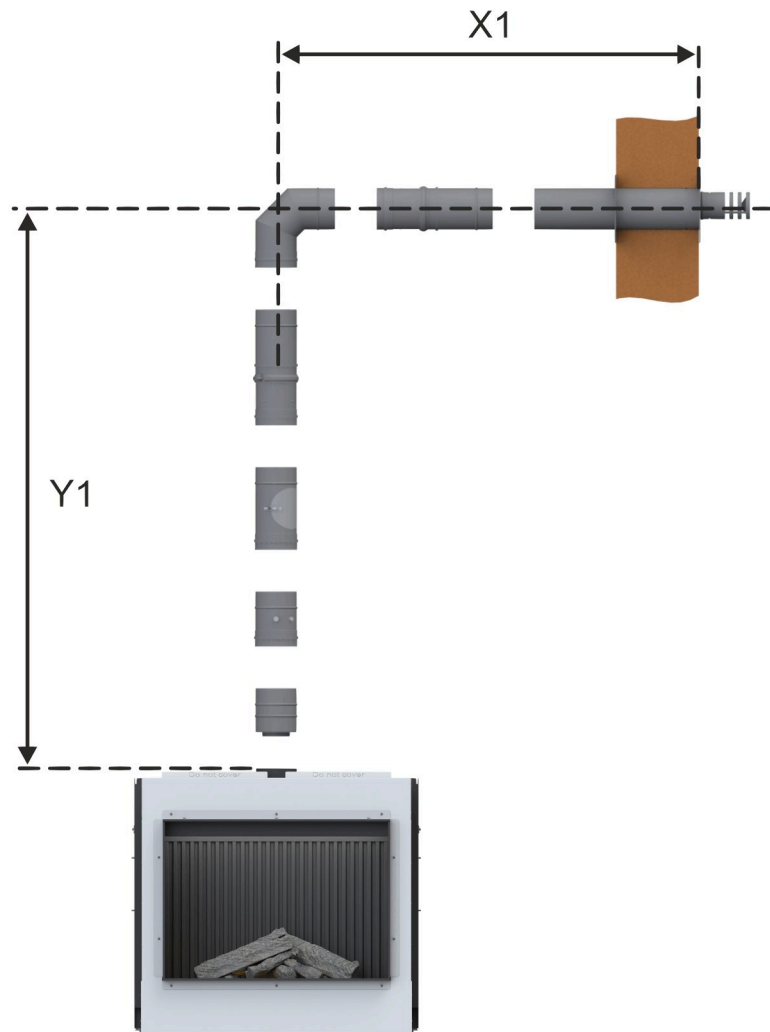

Abstand Y1 (min. - max.)	Abstand X1 (min. - max.)	Abstand Y2 (min. - max.)	Abstand X2 (min. - max.)	Stauplatte (Breite)
1,65 - 2,65 m	0,15 - 0,75 m			-
2,65 - 3,65 m	0,15 - 1,75 m			-

BRUNNER LAS (Gas) - BKG 4.0 Flach 54-68

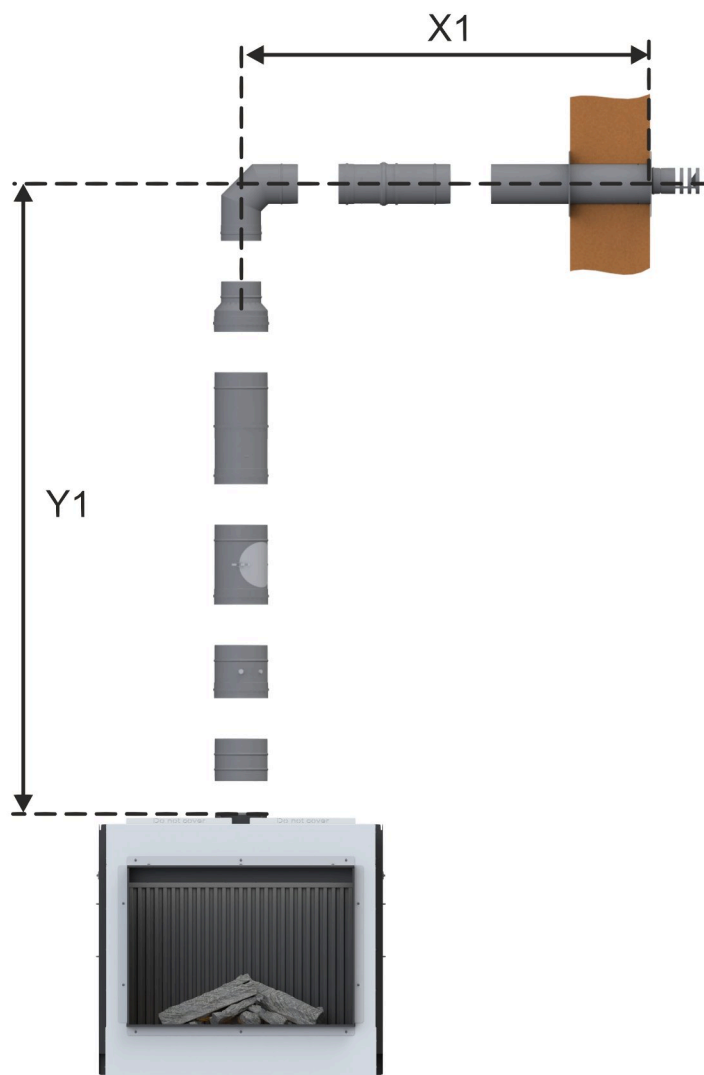

Abstand Y1 (min. - max.)	Abstand X1 (min. - max.)	Abstand Y2 (min. - max.)	Abstand X2 (min. - max.)	Stauplatte (Breite)
0,65 - 1,15 m	0,15 - 0,75 m			-
1,15 - 2,15 m	0,15 - 2,75 m			-

BRUNNER LAS (Gas) - BKG 4.0 Flach 54-68

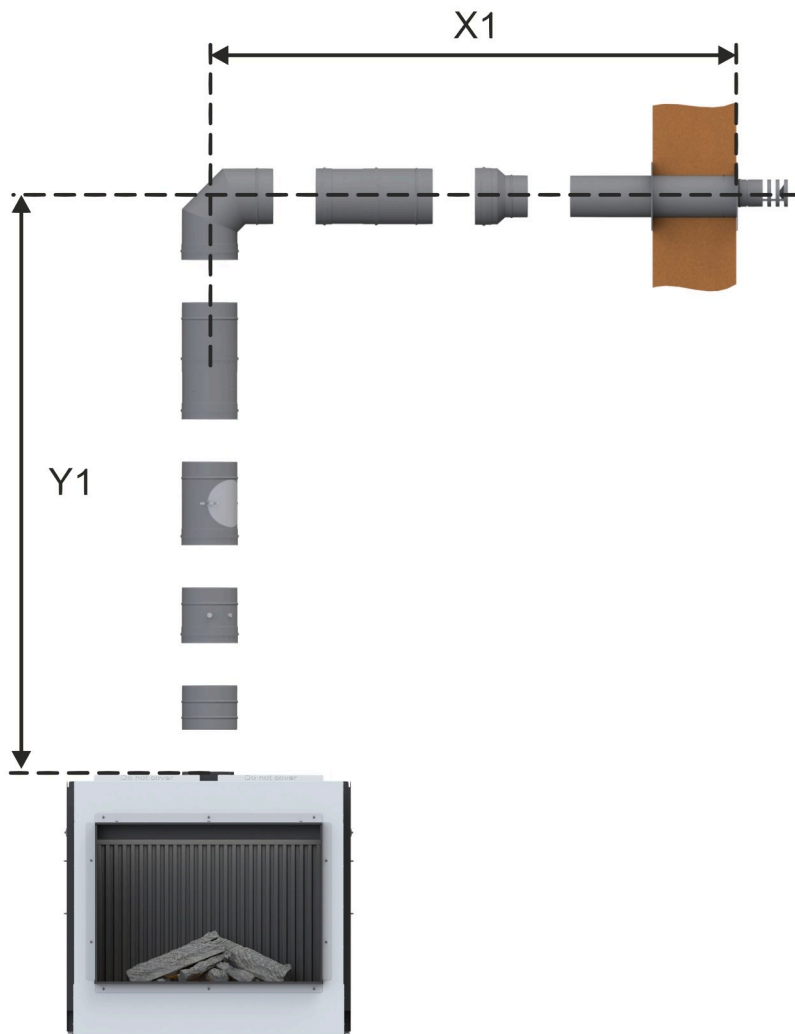

Abstand Y1 (min. - max.)	Abstand X1 (min. - max.)	Abstand Y2 (min. - max.)	Abstand X2 (min. - max.)	Stauplatte (Breite)
0,75 - 1,25 m	0,25 - 1,85 m			-
1,25 - 3,25 m	0,25 - 4,85 m			-

BRUNNER LAS (Gas) - BKG 4.0 Flach 54-68

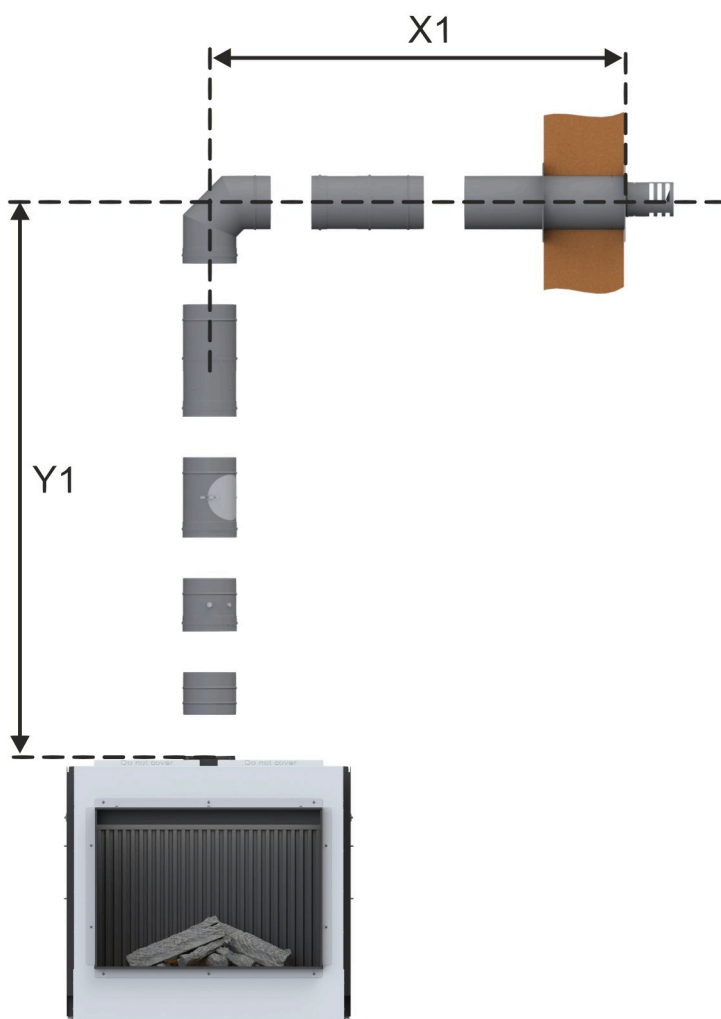

Abstand Y1 (min. - max.)	Abstand X1 (min. - max.)	Abstand Y2 (min. - max.)	Abstand X2 (min. - max.)	Stauplatte (Breite)
0,25 - 0,75 m	0,25 - 0,85 m			-
0,75 - 1,25 m	0,25 - 3,85 m			-
1,25 - 3,25 m	0,25 - 8,85 m			-

BRUNNER LAS (Gas) - BKG 4.0 Flach 54-68

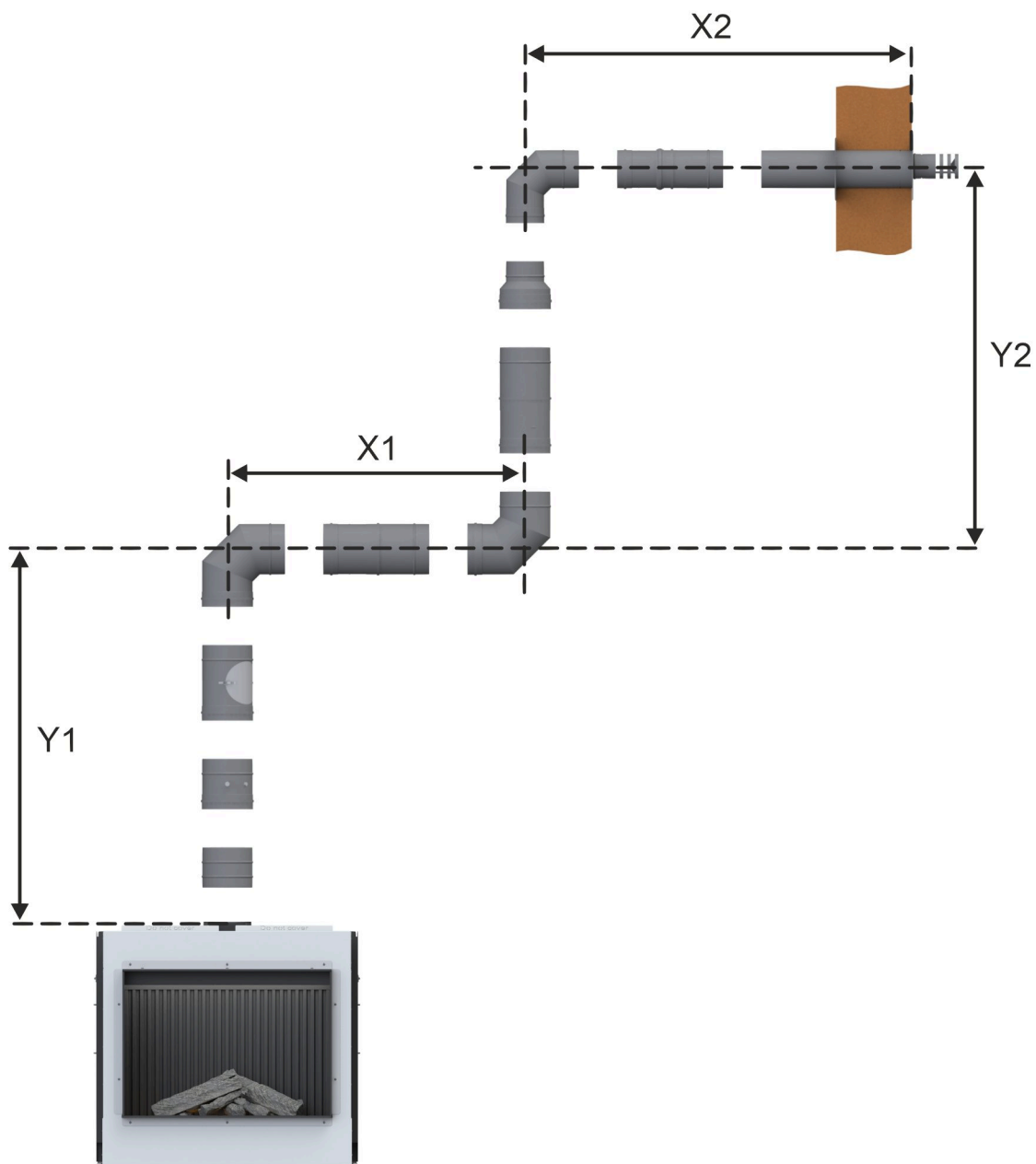

Abstand Y1 (min. - max.)	Abstand X1 (min. - max.)	Abstand Y2 (min. - max.)	Abstand X2 (min. - max.)	Stauplatte (Breite)
0,25 - 0,75 m	0,5 - 1,0 m	0,9 - 1,4 m	0,15 - 0,75 m	-
0,75 - 1,25 m	0,5 - 1,0 m	0,4 - 0,9 m	0,15 - 0,75 m	-
1,25 - 3,25 m	0,5 - 1,5 m	0,9 - 2,4 m	0,15 - 0,75 m	-
1,25 - 3,25 m	0,5 - 3,5 m	1,4 - 3,4 m	0,15 - 0,75 m	-

Planung und Einbau - BKG 4.0 Flach 54-68 - Premium Fire 2

Geprüft nach		EN 613	EN 613	EN 613
Gasart		Erdgas E (G20)	Erdgas LL (G25)	Flüssiggas (G30 / G31)
Zulassungsnummer		0063 DL 3986	0063 DL 3986	0063 DL 3986
Installationsart		C11 / C31 / C91	C11 / C31 / C91	C11 / C31 / C91
Geräteklasse		I _{2ELL}	I _{2ELL}	I _{3B/P}
Energielabel / EEI		A / 88 ¹⁾	A / 88 ¹⁾	A / 88 ¹⁾
Nennleistung	kW	9,6	9,2	9,6 / 8,4
Leistungsbereich	kW	6,1 - 9,6	5,8 - 9,2	5,5 - 9,6 / 4,6 - 8,4
konzentr. Abgas- / Verbrennungsluftstutzen Ø	mm	100 / 150; 130 / 200	100 / 150; 130 / 200	100 / 150; 130 / 200
Effizienzklasse		1	1	1
NOx-Klassifikation		4	4	4
Gasanschluss	Zoll	R ½"	R ½"	R ½"
Gasverbrauch Erdgas (max)	m³/h	1,13	1,24	-
Gasverbrauch Flüssiggas (max)	g/h	-	-	970 / 790
Druck Nennanschluss	mbar	20	20	50
Düsendruck (max) warm ²⁾	mbar	10,6	13,1	29
Düsendruck (max) kalt ³⁾	mbar	9,9	12,4	29
Düsendruck (min) ⁴⁾	mbar	5,0	6,1	9,4
Luftquerschnitte				
Zuluft	cm²	2 x 150	2 x 150	2 x 150
Umluft	cm²	-	-	-
min. Abstände Feuerstätte				
zur Kaminhülle	cm	1	1	1
zu Verkleidung, Dämmschicht	cm	2	2	2
zum Boden (nicht brennbar)	cm	1	1	1
Wärmedämmung				
zu sonstiger Anbauwand	cm	4	4	4
zu schützender / brennbarer Anbauwand	cm	8	8	8
zur Decke ⁵⁾	cm	2 + 4	2 + 4	2 + 4
zu schützende Decke ⁶⁾	cm	2 + 8	2 + 8	2 + 8
Gewicht				
Gesamtgewicht	kg	126 - 155	126 - 155	126 - 155
Anforderung/Grenzwerte				
Deutschland / Österreich	DVGW-TRGI technische Regeln für Gasinstallationen (Arbeitsblatt G600), FeuVO der Bundesländer / ÖVGW-Richtlinien G1 (Erdgas) und G2 (Flüssiggas)			

- 1) mit ausgeschalteter Glutbeleuchtung in den Betriebsarten Mindestwärmeleistung und Standby
- 2) beide Brenner auf max. Nennleistung (Gerät warm)
- 3) beide Brenner auf max. Nennleistung (Kaltstart)
- 4) beide Brenner auf min. Nennlast
- 5) Zwischendecke (2cm) mit Luftspalt (14cm) zu Dämmschicht (4cm)
- 6) Zwischendecke (2cm) mit Luftspalt (10cm) zu Dämmschicht (8cm)

Ulrich Brunner GmbH
 Zellhuber Ring 17 - 18
 D-84307 Eggenfelden
 Telefon: +49 / (0)87 21 / 7 71-0
 Telefax: +49 / (0)87 21 / 7 71-100
 info@brunner.de | www.brunner.de

BRUNNER[®]
 by **barbas**.